

**MODEL KP-300
ACCESS CONTROL READER KEYPAD**

OPERATING INSTRUCTIONS



Alarm Controls
(800) 645-5538
www.alarmcontrols.com

TABLE OF CONTENTS

Introduction	3
Features	3
Specifications	4
Installation	5
Precautions	5
Harness Connections.....	6
LED Indicators	7
Programming Instructions.....	8
Set Keypad Into Programming Mode With the Installer Code.....	8
Direct Access to Programming Mode (DAP Code)	8
Refresh Code.....	8
Default Keypad Value Table	9
Keypad Programming.....	9
Programming Mode Using Factory Set Installer Code ...	10
Changing the Installer Code	10
Record an EM Card to Operate Output 1	10
Set User PIN to Operate Output 1	10
Record an EM Card & User PIN to Operate Output 1 ...	11
Record an EM Card & Common User Code to Operate Output 1.....	11
Close the Programming Mode	11
Operation.....	12
Unlock Door With an EM Card	12
Unlock Door With a User PIN	12
Unlock Door With an EM Card & User PIN	12
Unlock Door With an EM Card & Common User Code	12
Feature Programming	12
Programming Criteria for Codes	12
Installer Code (Location 01).....	14
Common User Code (Location 03, 04).....	14
Record/Delete PINs or Cards	14
Visitor Codes (Location 40).....	16
Set a One-Time Visitor Code	17
Set a Time Limit Visitor Code	17
Delete a Visitor Code	18
Clear All Visitor Codes	18
Configure Output 1/Output 2 Modes (Location 51,52) ...	18
Personal Safety and Keypad Lockout (Location 60).....	19
User PIN Entry Mode (Location 70)	19

TABLE OF CONTENTS (Continued)

Tone On/Off Selection (Location 71).....	20
Output Automation Announcer (Location 72)	20
Yellow LED Flashing On/Off During Standby (Location 73)	20
Operation Modes (Location 94)	21
Application Example	21
Application Hints For the Auxiliary Terminals	22
Glossary	23
Programming Summary Chart.....	24

INTRODUCTION

The KP-300 is a weather-proof, vandal resistant, mullion mount keypad. It combines the functions of a digital keypad and proximity EM card reader in one unit.

The KP-300 has been designed to work independently as a stand alone keypad. The keypad has multiple functions that can be programmed to meet a variety of applications.

FEATURES

- Weather-proof to IP65
- Vandal resistant die cast zinc alloy housing
- Metal back lit key buttons for visibility in dark areas
- Mullion surface mount, can be mounted on door frame or wall
- Operates with EM card only, PIN and card or PIN
- Two programmable S.P.D.T. relay outputs
- Output 1 has a capacity of 1000 PINs and/or cards
- Output 2 has a capacity of 100 PINs and/or cards
- Fifty visitor codes, programmable for one time use or with time limit
- Yellow and green LEDs indicate keypad status
- Lifetime limited warranty

SPECIFICATIONS

Operating Voltage12 VDC Nominal, 11-15 VDC
Operating Current60 mA (quiescent)
95 mA (two relays energized)
Operating Temperature -20°C to +70°C
Environmental Humidity5 - 95% relative humidity,
non-condensing

Working Environment and Ingress

Protection.... Indoor or Outdoor, IP65 Weather-proof
Number of Users -

Output 1 has a capacity of 1000 PINs and/or cards
Output 2 has a capacity of 100 PINs and/or cards
Fifty visitor codes, programmable for one time use
or with time limit

Egress Button -

Programmable for Instant, Delay with warning
and/or alarm

Momentary or latching contacts for the Exit Delay

Output Contact Ratings -

Output Relay 1, N/O and N/C dry contacts, rated
2A @ 24 VDC maximum

Output Relay 2, N/O and N/C dry contacts, rated
1A @ 24 VDC maximum

Dimensions

7-5/64" H x 1-13/16" W x 1" D

Package Contents -

- KP-300 Keypad
- Two EM Cards. Part number EM-10 (additional cards are available)
- Two Mounting Screws and Fasteners
- One 1N4004 Diode
- One Hex Key
- Instruction Manual

INSTALLATION



Front Cover



Rear Cover

1. Remove flat head screw from the bottom of the keypad with the provided hex key.
2. Mount the back cover to the door frame or wall.
3. Pass the wire harness through the center opening in the back plate.
4. Plug the connector at the end of the wire harness into the PCB.
5. Place the back cover on the front cover and secure with screw.

PRECAUTION

Prevent Interference

The EM card reader works at a frequency of 125 kHz. Installation precautions are necessary.

Make sure the location for installation has no strong low frequency EM signals in the range of 100 to 200 kHz.

If there is more than one keypad in the installation, be sure that they are at least two feet apart.

HARNESS CONNECTIONS

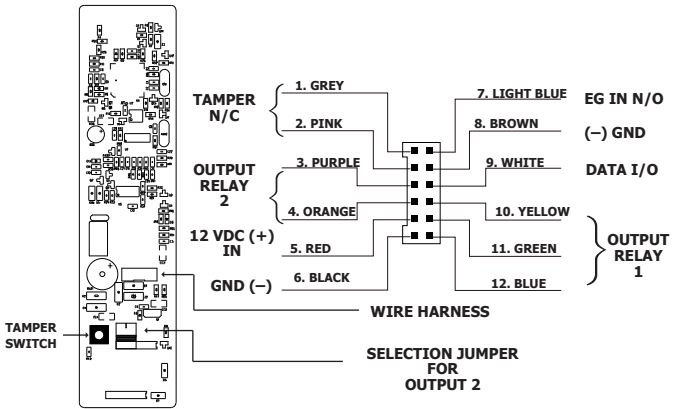

12 VDC Power Input (Red & Black Leads)

Connect a 12VDC power supply. Connect with the (+) to the Red lead and the (-) to the Black lead.

Normally-Closed Tamper Switch (Grey & Pink Leads)

Connect this N/C terminal to the 24 hour protective zone of an alarm system if necessary. the alarm will sound if the front cover of the KP-300 is removed.

Output Relay 2 (Purple & Orange Leads)

A dry relay contact rated for 1A @ 24 VDC which is jumper selectable is controlled by the PINs/Cards.

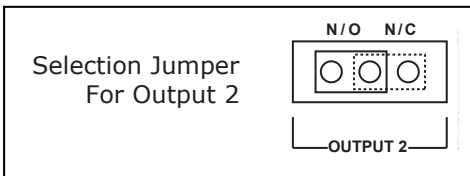

EG IN (Egress Input) (Light Blue Lead)

A Normally Open (N/O) input terminal referenced to (-) ground. Connect a Normally Open exit station to activate Output 1.

Exit station is normally located on the interior of the building.

More than one exit station can be connected in parallel to this terminal. Leave this terminal open if not used. See programming Location 90 for more information about the Egress Input.

GND (-) (Common Ground) (Brown Lead)

A common ground point of the keypad. It is common to the black lead.

Output 1 (Output 1 Relay) (Yellow, Green & Blue Leads)

2 Ampere relay, dry contact, controlled by Group 1. Recommended for door strike and magnetic locks. Yellow lead is Normally Closed (N/C), blue lead is Normally Open (N/O), and green lead is the common contact. Use N/C output for Failsafe operation and N/O for Fail-secure operation. The relay is programmable for Latching Mode or Momentary Timing Mode. See programming Location 51 for details.

LED INDICATORS

Yellow Led Monitors Power Input And Key Press.
Green Led On When Output 1 Is Active

YELLOW LED INDICATOR AND TONES

LED SIGNALS	TONES	STATUS
ON	NONE	IN PROGRAMMING MODE
1 FLASH	1 BEEP	SUCCESSFUL KEY ENTRY
2 FLASHES	2 BEEPS	SUCCESSFUL CODE ENTRY
5 FLASHES	5 BEEPS	FAULTY CODE ENTRY
CONTINUOUS FLASHING	CONTINUOUS TONE	POWER UP DELAY
1 FLASH IN 1 SECOND	NONE	IN STANDBY MODE
NONE	1 LONG BEEP	PIN STORED IN SYSTEM

- Beeps and Tones can be silenced through Location 71
- Output Relay activation beep can be selected by Location 72
- Standby Flashing option can be selected by Location 73

PROGRAMMING INSTRUCTIONS

Set Keypad Into Programming Mode With The Installer Code

Important Note:

DO NOT TURN OFF POWER WHEN IN PROGRAMMING MODE as it may cause data loss or errors in programmed features.

The keypad beeps continuously for approximately one minute after power up.

Wait for the beeping to stop before entering in the Installer Code to access Programming Mode.

Factory set installer code is **0 0 0 0 * ***. For security purposes, it is advisable to program a new Installer Code.

2 beeps confirm a valid Installer Code. The Yellow LED is constantly on while in programming mode.

Direct Access To Programming Mode With The "DAP" Code

In the case of a lost Installer Code it is still possible to access the programming mode using the Direct Access to Programming (DAP) code.

1. Switch OFF power for 1 minute.
2. Switch ON power. The keypad is in power-up mode for approximately 1 minute and there is a continuous beep.
3. Create a momentary closure between the Brown and Light Blue wire to enable DAP function (This must be done while in power-up mode).
4. Key in **2 8 2 8 * ***. The existing Installer Code is erased and the power-up tone stops. The keypad is now in Programming Mode and is ready for the entry of a new Installer Code.

Refresh Code

The keypad can be refreshed to the factory defaults.

Enter the code **9 9 9 9 #** to refresh the keypad. All previously entered data will be erased except for the Installer Code.

DEFAULT KEYPAD VALUE TABLE

LOCATION	PARAMETERS	DEFAULT FUNCTION & VALUES
01	INSTALLER CODE	0 0 0 0 FACTORY SET NOT A DEFAULT VALUE
02	--	--
03	COMMON USER PIN O/P 1	--
04	COMMON USER PIN O/P 2	--
10	USER PINS & CARDS O/P 1	--
20	USER PINS & CARDS O/P2	--
40	VISITOR CODES	--
51	O/P MODE OF O/P 1	TIME = 5 SECONDS MOMENTARY
52	O/P MODE OF O/P 2	TIME = 5 SECONDS MOMENTARY
60	SAFETY & LOCKOUT	CODE=1, 10 FALSE CODES LOCK OUT 1 MINUTE
70	USER CODE ENTRY MODE	CODE=2, MANUAL ENTRY MODE
71	tone ON/OFF SELECTION	CODE=1, TONE ON
72	O/P OPERATION ANNOUNCER	CODE=1, NOTIFICATION BEEP ON
73	STATUS LED FLASHING	CODE=1, FLASHING EN- ABLED
94	OPERATION MODES	CODE=0, STAND ALONE KEYPAD

NOTE: The DAP Code **2 8 2 8** and the Refreshing Code **9 9 9 9** are fixed in the keypad and cannot be changed in any way.

Keypad Programming

Wait until beeping stops (approximately 1 minute after power up) to begin programming.

A total of 1100 User PINs and/or Cards are available -
 Output 1 (Group 1): 1,000 PINs and/or Cards
 Output 2 (Group 2): 100 PINs and/or Cards

Set Keypad Into Programming Mode Using The Factory Set Installer Code

Enter **0 0 0 0 * *** to enter Programming Mode. Two beeps will indicate successful entry.

Changing The Installer Code

While in Programming Mode enter **0 1 3 2 8 9 #**. This will change the Installer Code to "3289" and is used as an example of a new Installer Code. Two beeps will indicate successful entry.

Record An EM Card To Operate Output 1

ENTER **1 0 1 001 READ CARD #**
(a) (b) (c) (d) (e)

- (a) 10 = Programming location for Output 1
- (b) 1 = Programming option for EM card
- (c) 001 = ID Number. Must be 000 to 999
- (d) *READ CARD* = Place card within range of the keypad
- (e) # = Confirm card read. 2 beeps indicate successful entry

Set User Pin To Operate Output 1

ENTER **1 0 2 002 8321 #**
(a) (b) (c) (d) (e)

- (a) 10 = Programming location for Output 1
- (b) 2 = Programming option for User PIN
- (c) 002 = ID Number. Must be 000 to 999
- (d) 8321 = The programmed User PIN. "8321" is used as an example.
- (e) # = Confirm entry. 2 beeps indicate successful entry

Record An EM Card & User PIN To Operate Output 1

ENTER **1 0 3 003 READ CARD 6123 #**
(a) (b) (c) (d) (e) (f)

- (a) 10 = Programming location for Output 1
- (b) 3 = Programming option for EM card and User PIN
- (c) 003 = ID Number. Must be 000 to 999
- (d) *READ CARD* = Place card within range of the keypad
- (e) 6123 = User PIN associated with the EM card. 6123 is used as an example.
- (f) # = Confirm card read. 2 beeps indicate successful entry

Record EM Card & Common User Code To Operate Output 1

A common user code must be set at programming Location 03 first for this operation mode. The code can be used for all EM cards in this operation mode.

ENTER **1 0 4 004 READ CARD #**
(a) (b) (c) (d) (e)

- (a) 10 = Programming location for Output 1
- (b) 4 = Programming option for EM card and Common User code
- (c) 004 = ID Number. Must be 000 to 999
- (d) *READ CARD* = Place card within range of the keypad
- (e) # = Confirm card read. 2 beeps indicate successful entry. The Common User code is associated with this user automatically.

Close The Programming Mode

Enter *** ***. 2 beeps indicate that programming mode is closed

OPERATION

Unlock Door With An EM Card

READ CARD

A tone will sound and the green LED will illuminate. The door is now unlocked.

Unlock Door With A User Pin Code

ENTER USER PIN 8 3 2 1 #

"8321" for example. A tone will sound and the green LED will illuminate. The door is now unlocked.

Unlock Door With An EM Card & User Pin

READ CARD 8 3 2 1 #

"8321" for example. A tone will sound and the green LED will illuminate. The door is now unlocked.

Unlock Door With An EM Card & Common User Code

READ CARD 8 3 2 1 #

"8321" for example. A tone will sound and the green LED will illuminate. The door is now unlocked.

FEATURE PROGRAMMING

The feature values are set and stored using the Programming Locations. Programming can be made continuously and it is not necessary to program in sequence order.

Programming Criteria For Codes

PRIME CODES: PIN, Installer, Duress, Common User and Visitor are all examples of Prime Codes. These codes must be unique in the programming. A Prime Code may not be duplicated for a Secondary Code to work with an EM card or vice versa.

PRIME CARDS: All EM cards are Prime Cards. The cards used for Outputs 1 and 2 must be unique. The card always has priority to be read when working in "EM card & Secondary PIN" or "EM card & Common User PIN" mode.

WARNING FOR A REPEATED USE OF PRIME CODE OR CARD: One long beep is given if a code/PIN is entered or a card is read if that prime code or card is repeated. This indicates that the code/PIN or card was already entered. The programming is not valid.

SECONDARY USER PINS: The Secondary User PINs are used to enhance security. They are used after a card in "EM card & Secondary User PIN" programming. Secondary Codes can be repeated but they must not be a duplicate of a Prime Code. The keypad will reject a duplicated Prime Code for a Secondary User PIN or vice versa.

ADVANTAGES OF USING SECONDARY USER PINS: The repeated Secondary User PINs can be used as a group Common User code for a group of EM cards thereby simplifying programming.

SECURITY LEVEL COMPARISON OF THE SECONDARY USER PIN/CODE FOLLOWING CARD READING

EM CARD & COMMON USER CODE: All EM cards use the same user code. Security level is better than a card alone since the card bearer will also need to know the code for access.

EM CARD & GROUP USER CODE: EM cards are separated by group. Security level is better than a common code since the card bearer will also need to know the group code for access.

EM CARD & UNIQUE SECOND USER CODE: Each card is associated with a unique user code. Only a person with knowledge of the code can use the card for access.

Make a list of user names and associated codes/pins/cards and keep it in a secure area.

Program the Installer Code (Location 01)

The Installer Code is the authorization code for entering the Programming Mode. It is not a user code.

The Installer Code must be 4 to 8 digits in length.

There is only one Installer Code. Previous Installer Codes are replaced with the new code.

To set a new Installer Code -

1. Set the keypad to Programming Mode
2. Enter **01, 4 to 8 digit new code, #**

Program the Common User Code/PINs for Output 1 (Location 03) and Output 2 (Location 04)

The Common User Code/PINs 1 and 2 are prepared for operating Outputs 1 and 2 respectively as an enhanced code. The Common User Code/PIN must work in the form of "Card & Common User Code/PIN" to operate the outputs. See Locations 10 and 20 for more information. A Common User PIN alone will not operate the outputs directly.

To set the Common User Code/PIN -

1. Set the keypad to Programming Mode
2. Enter **03 (or 04), 4 to 8 digit code, #**

Record/Delete PINs or Cards for Output 1 & 2

A total of 1100 User PINs and/or Cards are available -

Output 1 (Group 1): 1,000 PINs and/or Cards

Output 2 (Group 2): 100 PINs and/or Cards

<u>LOCATION</u>	<u>MEDIA</u>	<u>USER ID</u>	<u>CARD/USER PIN</u>	<u>SUBMIT</u>
10 or 20	1 to 5	000 to 999	4 to 8 DIGITS	#

LOCATION -

10 = Group 1

20 = Group 2

MEDIA -

- 1 = EM Card only
- 2 = PIN only
- 3 = EM Card & Secondary Pin
- 4 = EM Card & Common Pin
- 5 = Delete a PIN/Card from the selected User ID

USER ID -

- Group 1: 000-999
- Group 2: 001-100

CARD/USER PIN -

- The User PINS are 4 to 8 digits long. Key in the User PIN for each User ID and confirm entry with the # key.
- Place the EM card close to the keypad reader to associate it with an ID and confirm entry with the # key.
- Read the card first and then key in the secondary user PIN to associate it with an ID. Then confirm entry with the # key.

PROGRAMMING AND OPERATION EXAMPLES

EM CARD ONLY -

To program -

Set keypad to Programming Mode and

ENTER **1 0 1 001 READ CARD #**
(a) (b) (c) (d) (e)

- (a) 10 = Programming location for Output 1
- (b) 1 = Programming option for EM card only
- (c) 001 = ID Number. Must be 000 to 999
- (d) *READ CARD* = Place card within range of keypad.
1 beep confirms entry
- (e) # = Confirm card read. 2 beeps indicate successful entry

Operation -

While in Operation Mode, place card within range of the reader. 2 beeps confirm the card is read and Output 1 is activated.

DELETE A USER ID -

Set keypad to Programming Mode and

ENTER **1 0 5 001 #**

(a) (b) (c) (d)

- (a) 10 = Programming location for Group 1
- (b) 5 = Programming option deletion
- (c) 001 = ID Number. Must be 000 to 999
- (d) # = Confirm entry. 2 beeps indicate successful entry

DELETE AN EM CARD -

Set keypad to Programming Mode and

ENTER **1 0 5 READ CARD #**

(a) (b) (c) (d)

- (a) 10 = Programming location for Group 1
- (b) 5 = Programming option deletion
- (c) *READ CARD* = Put the card within range of the keypad
- (d) # = Confirm card read. 2 beeps indicate successful entry

CLEAR A WHOLE GROUP -

Set keypad to Programming Mode and

ENTER **1 0 0999 #**

(a) (b) (c)

- (a) 10 = Programming option for Group 1 (20 for Group 2)
- (b) 5 = Programming option for Group deletion
- (c) # = Confirm entry. 2 beeps indicate successful entry

Visitor Codes (Location 40)

The Visitor Codes are the temporary codes for operating Output 1 only. They can be programmed as one-time codes or time-limited codes. Visitor codes are cleared automatically after expiration.

LOCATION VISITOR ID VISITOR PERIOD VISITOR CODE SUBMIT
40 01 to 50 00 or 01 to 99 4 to 8 Digits #

VISITOR ID - 50 Visitor ID's (01 to 50)

VISITOR PERIOD -

00 = One-time visit. Cleared after one use.

01 to 99 = Time limit in hours from 1 hour to 99 hours. Code is cleared after time expires.

VISITOR CODE -

- The codes are 4 to 8 digits long.
- The Visitor Code must be the same length as the Installer Code for Auto
- Mode code entry.
- Visitor Codes will not reset Duress Output

Note: Visitor Codes are cleared after power down to prevent extension of the Visitor period.

PROGRAMMING EXAMPLES

SET A ONE TIME USE VISITOR CODE -

To program -

Set keypad to Programming Mode and

ENTER **4 0 0 1 00 8321 #**

(a) (b) (c) (d) (e)

(a) 40 = Programming option for Visitor Code

(b) 01 = Visitor ID number

(c) 00 = Programming option for One Time use

(d) 8321 = The programmed Visitor PIN

(e) # = Confirm entry. 2 beeps indicate successful entry

SET A TIME LIMIT VISITOR CODE -

To program -

Set keypad to Programming Mode and

ENTER **4 0 0 1 03 8321 #**

(a) (b) (c) (d) (e)

- (a) 40 = Programming option for Visitor Code
- (b) 01 = Visitor ID number
- (c) 03 = Programming option in hours. 3 hours in this example
- (d) 8321 = The programmed Visitor PIN
- (e) # = Confirm entry. 2 beeps indicate successful entry

DELETE A VISITOR CODE -

Set keypad to Programming Mode and

ENTER **4 0 0 1 #**

(a) (b) (c)

- (a) 40 = Programming option for Visitor Code
- (b) 01 = Visitor ID number
- (c) # = Confirm entry. 2 beeps indicate successful entry

CLEAR ALL VISITOR CODES -

Set keypad to Programming Mode and

ENTER **4 0 0 9 9 9 #**

(a) (b) (c)

- (a) 40 = Programming option for Visitor Code
- (b) 0999 = Delete all codes from this location command
- (c) # = Confirm entry. 2 beeps indicate successful entry

Configure Output 1 & Output 2 Modes (Location 51, 52)

Two relay outputs are programmable for latching and momentary operation.

LOCATION	OUTPUT MODE AND TIME	SUBMIT
51 or 52	0 or 1 to 99999	#

LOCATION -

51 = Output 1

52 = Output 2

OUTPUT MODE AND TIME -

0 = Latching Mode. Output is activated with valid entry and is then deactivated with a second valid entry.

1 to 99999 = Momentary Mode. Time in seconds from 1 second to 99999 seconds (default is 5 seconds). Output will remain active for the duration of the programmed time and then automatically deactivate when the time interval expires.

Personal Safety and Keypad Lockout (Location 60)

LOCATION	LOCKOUT MODE	SUBMIT
60	SEE BELOW FOR CODES	#

LOCKOUT MODE CODES -

00 = The Lockout feature is disabled

1 = After 10 successive failed entries, keypad locks for 1 minute (default)

5 to 10 = After 5 to 10 successive failed entries, keypad locks for 15 minutes

User PIN Entry Mode (Location 70)

LOCATION	ENTRY MODE	SUBMIT
70	1 or 2	#

ENTRY MODE -

1 = Auto Entry Mode. This mode eliminates the need to submit entries with the “#” key. In this mode all user PINs must be the same length as the Installer Code. For example: If the Installer Code is 5 digits, then all user PINs must be 5 digits as well.

2 = Manual Entry Mode (default). This mode requires the “#” key to submit entries. In this mode user PINs can be between 4 and 8 digits in length and need not match the length of the Installer Code.

Tone On/Off Selection (Location 71)

This selection allows the sounds (tones/beeps) to be set on or off. Please note that the tones for Warning and Power-Up are always audible.

LOCATION	MODE	SUBMIT
71	0 or 1	#

MODE -

0 = Silent

1 = Tones/beeps are audible (default)

Output Automation Announcer (Location 72)

The Announcer gives a notification tone to the user on the operation status of the output. There are two modes available. The announcer is off if silent mode is selected in Location 71.

LOCATION	MODE	SUBMIT
72	0 or 1	#

MODE -

0 = 2 beeps are sounded when a valid entry is submitted and an output is activated.

1 = 1 second long notification tone is sounded when a valid entry is submitted and an output is activated (default).

Yellow LED Flashing On/Off During Standby (Location 73)

LOCATION	MODE	SUBMIT
73	0 or 1	#

MODE -

0 = Yellow LED flashes during standby (default)

1 = Standby flashing is disabled

Operation Modes (Location 94)

LOCATION	MODE	SUBMIT
94	0	#

MODE -

0 = Stand Alone Mode (default). The keypad operates with complete functionality.

APPLICATION EXAMPLE

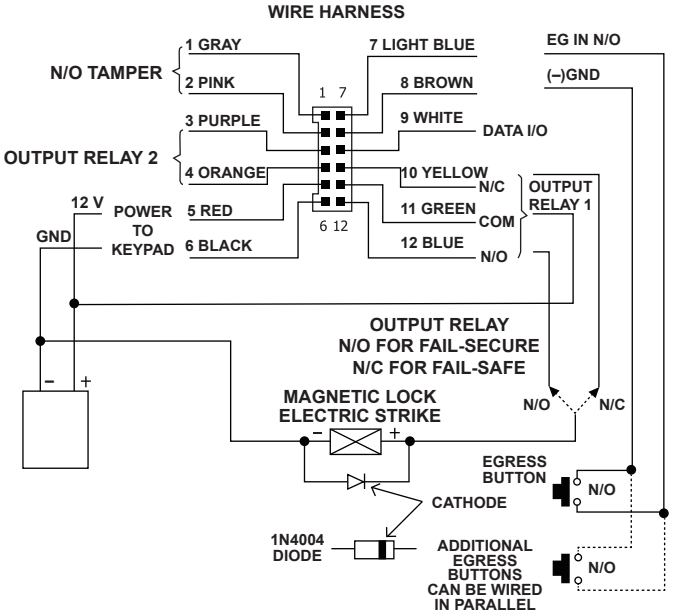

Note:

- Connect the 1N4004 as close as possible to the lock to absorb back EMF and prevent damage to the keypad. The 1N4004 is not required if the electric lock is AC operated.
- To avoid Electro-Static-Discharge (ESD) from interfering with the operation of the keypad, always ground the (-) terminal of the keypad to earth ground.

APPLICATION HINTS FOR THE AUXILIARY TERMINAL

Output 2: Shunting a N/C Zone

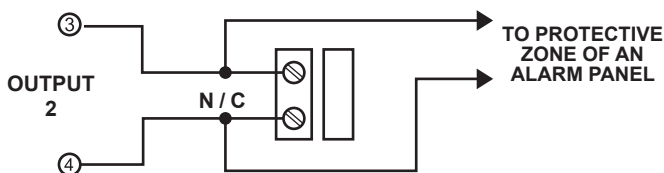

Use a N/O output contact to shunt a N/C protective zone.

Set output contact to Latching Mode (Output Mode = 0) using programming option 52.

Output 2: Alarm System Arming/Disarming

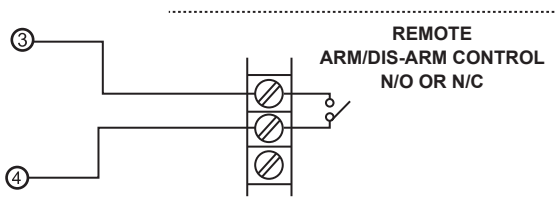

Use the N/O or N/C output contact to make an Arm/Disarm control of an alarm system.

Consult your alarm control panel manual for the appropriate output contacts to be used for Arm/Disarm control.

For single station systems, set output contact to Latching Mode (Output Mode = 0) using programming option 52.

For multi-station systems, set output contact to Momentary Mode (Output Mode = 1) using programming option 52.

Dry Contact

Dry contacts do not have voltage connected to them. The Relay Output contacts in the keypad are dry contacts.

N/C Contact

The contact is closed in the static state and open in the active state. The contact is open when the circuit is active.

N/O Contact

The contact is open in the static state and closed in the active state. The contact is closed when the circuit is active.

Transistor Open Collector Output

An open collector output is equivalent to a normally-open, (N/O), contact referring to ground, (-), the same as a relay contact connected to ground, (-). The transistor is normally turned Off, and the output switches to ground, (-), when turned On.

The Duress, Inter-lock and Key Active/Alarm Outputs are open collector outputs and the current is limited to 100 Ma. maximum and 24 VDC maximum.

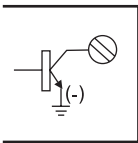

Equivalent

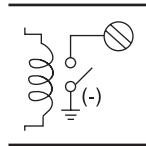

Open Collector Output

Output switches to Ground when activated

N/O Contact Output

Output switches to Ground when activated

PROGRAMMING SUMMARY CHART

Location	Parameter	Entry Limit & Code Options	Code Entry	Factory Default
01	Installer Code	4 to 8 Digits	0 1 <i>Installer Code #</i>	N/A
03	Common User PIN O/P 1	4 to 8 Digits	0 3 <i>Common User PIN 1 #</i>	N/A
04	Common User PIN O/P 2	4 to 8 Digits	0 4 <i>Common User PIN 2 #</i>	N/A
		<u>Code 1: Media</u>		
		1- EM Card		
		2- User PIN		
10	User PINs & Cards O/P 1	3- EM Card & User PIN	1 0 <i>Code 1 Code 2 Code 3 #</i>	N/A
		4 - EM Card & Common PIN		
		5 - Deletion of PIN		
		<u>Code 2: User ID</u>		
		Group 1 (10): 000 to 999		
		Group 2 (20): 001 to 100		
20	User PINs & Cards O/P 2	<u>Code 3: User PINs/Card</u>	2 0 <i>Code 1 Code 2 Code 3 #</i>	N/A
		4 to 8 Digits		
		<u>Code 1: Visitor ID</u>		
		01 to 50		
		<u>Code 2: Visitor Period</u>		
		00 - One time visit		
		01 to 99 - Time limit in hours		
40	Visitor Codes	<u>Code 3: Visitor PIN</u>	4 0 <i>Code 1 Code 2 Code 3 #</i>	N/A
		4 to 8 Digits		

PROGRAMMING SUMMARY CHART (Continued)

Location	Parameter	Entry Limit & Code Options	Code Entry	Factory Default
51	Output Mode of O/P 1	<u>Output Mode and Time</u> 0 - Latching Mode	5 1 Output Mode #	5 Seconds
52	Output Mode of O/P 2	1 - Momentary Mode 1 to 99999 seconds	5 2 Output Mode #	5 Seconds
60	Safety & Lockout	Lockout Code 00- Lockout disabled 1 - 10 Tries, lockout 1 minute 5 to 10 - 5 to 10 tries, lockout 15 minutes	6 0 Lockout Code #	Code = 1 10 Tries Lockout 1 minute
70	User Code Entry Mode	<u>Entry Mode</u> 1 - Auto Mode 2 - Manual Mode	7 0 Entry Mode Code #	Mode = 2 Manual Mode
71	Tone On/Off Selection		7 1 Mode Code #	Mode = 1 Tone Audible
72	O/P Operation Announcer	<u>Mode</u> 0 - Off 1 - On	7 2 Mode Code #	Mode = 1 1 Second Tone
73	Status LED Flashing		7 3 Mode Code #	Mode = 1 LED Flashes
94	Operation Mode	Code = 0, Stand Alone Keypad	9 4 0 #	Mode = 0 Keypad Mode

PROGRAMMING SUMMARY CHART (Continued)

System Code	Function	Code Entry	Result
0000	<p>Factory set Installer Code used to set system in programming mode for the first time. This is not a permanent system code. It will be changed if a new Installer Code is programmed.</p>	<p>0000 * * Or New Master Code * *</p>	<p>System in Programming Mode</p>
9999	<p>Refresh Code: Set all functions back to factory default values</p>	<p>9999#</p>	<p>All Programming as per Factory Defaults</p>
2828	<p>Dap Code: Direct Access to Programming Mode. Valid only in the power-up delay period.</p>	<p>Location 0999#</p>	<p>Whole Group of Users is Cleared</p>
* *	<p>Exit Programming Mode</p>	<p>* *</p>	<p>System in Operational Mode</p>

ALARM CONTROLS CORPORATION PRODUCT LINE

U.L. LISTED MAGNETIC LOCKS

MAGNETIC LOCK MOUNTING BRACKETS

MAGNETIC LOCK DRESS-UP COVERS

MAGNETIC LOCK DRILL JIGS

SELF-CONTAINED DIGITAL KEYPADS

U.L LISTED REQUEST TO EXIT STATIONS

EXPLOSION-PROOF REQUEST TO EXIT STATIONS

MORTISE CYLINDER STATIONS

VANDAL RESISTANT REQUEST TO EXIT STATIONS

REQUEST TO EXIT STATIONS WITH BUILT-IN TIME DELAY

RELAYS AND RELAY BASES

TIME DELAY MODULES

AUDIBLE INDICATORS

DELAYED EGRESS STATIONS

CONTROL PANELS

EMERGENCY DOOR RELEASES

PUSH PLATES

ZONE ANNUNCIATORS

GRAPHIC ANNUNCIATORS

CUSTOM PLATES

LIFE TIME PRODUCT WARRANTY

